

Features

- 2 independent delay channels (or 4 or 8 in option)
100 ps delay resolution (or 1 ps in option)
50 ps channel to channel RMS jitter (4 ps in option)
- Output pulse 1.5 to 5 V / 50 Ω, 1 ns rise and fall time with independent control of width, polarity, amplitude, burst and MUX mode
- Up to 50 MHz Independent trigger rate (repetitive, single or burst) for every channel
- External trigger mode from two inputs with pre-scaler or internal trigger mode from three synchronous programmable timers or command
- Gate (or second trigger) input
- External clocking up to 240 MHz (user programmable)
- Controlled via USB and Ethernet (or Bluetooth in option)
- Ultra-compact packaging and low power
- DC +5 V power supply. An External AC (80 to 230 V) to DC compact power supply is furnished
- Channel output amplitude options: 3 V to 10 V or 15 V to 50 V or LVDS level

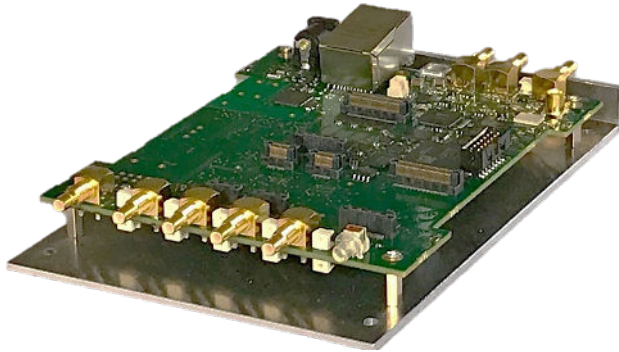

GFT1804 view

Applications

- System Laser Timing Control
- ATE Application
- Laser Pulse Picking
- Precision Pulse Application
- Instrument Triggering
- Component Testing

Description

The GFT1804 Pulse & Delay Generator provides 2 (or 4 or 8 in option) independent delayed pulses. Delays up to 100 seconds can be programmed with 100 ps resolution and channel to channel jitter less than 50 ps RMS. An option allows to enhance delay resolution to 1 ps and provide 500 ps precise pulse with 4 ps RMS jitter.

SMB outputs deliver 1.5 V to 5 V, 1 ns rise time pulses, into 50 Ω. Pulse amplitude, polarity, width and burst count are adjustable on each output channel. In option, pulse amplitude can be 3 V to 10 V or 15 V to 50 V into 50 Ω or LVDS level.

The model GFT1804 offer two inputs or three internal synchronized timers (adjustable from 0.01 Hz to 50 MHz) or software command for triggering all selected delay channel. Either trigger rate may be set as one-shot or repetitive. Gate input allows to quickly inhibit all selected channel Outputs: this input function can be selected as a second External Trigger or as an input/output for daisy chaining two GFT1804 to increase channel number.

The generator uses an internal 100 MHz TCXO clock reference, or an external user programmable (from 10 MHz to 240 MHz) clock (sine or square).

GFT1804 parameters can be remote controlled via Ethernet or USB to UART (or Bluetooth in option).

Application example: The GFT1804 is well suited to synchronize all the devices of a Picosecond Laser System with only one compact unit and one GUI. In this application the "Clock reference input" of the pulse and delay generator receives a signal (80 MHz for example) from laser oscillator via an O/E (optical to electrical converter) like an GFT300 module for example.

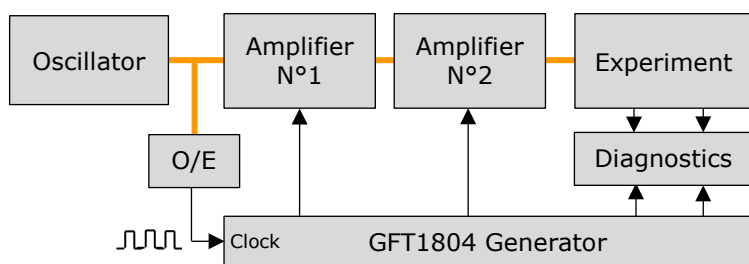

Picoseconde Laser System

From the GFT1804 Generator each amplifier (Pump-laser, Q-switch, Pockel cell ...) or diagnostic instruments (Digitizer, Calorimeter, CCD camera ...) can receive repetitive or single pulses (adjusted in rate, delay, amplitude, polarity and width) synchronized on "Clock reference input" with a very low jitter.

From generator 4 GPIO (input or output) under software control allow command for security or control to low frequency devices.



Specifications

Delay channels	
Number	2 independents (or 4 or 8 in option)
Range	100 seconds
Resolution	100 ps (1ps in option)
RMS jitter	<50 ps + delay x 10 ⁻⁷ , channel to channel (up to 4 ps with option 3 + 6) <1 ns, external trigger to any channel <50 ps, external clock to any channel (10 ps with option 3)
Accuracy	<250 ps + delay x 10 ⁻⁶ (<100 ps + delay x 10 ⁻⁶ with option 3)
Time base	Internal 200 MHz, ± 1 ppm stability
External Trigger Mode	
Input "TRIG"	Rate single or repetitive up to 40 MHz, with prescaler, adjustable threshold from +100 mV to +5 V (step 1 mV), adjustable positive or negative slope and 5 ns min pulse width
Trigger delay	<85 ns (insertion delay)
Internal Trigger Mode	
Rate repetitive	From three Timers with frequency = 0.01 Hz to 50 MHz (in step of 5 ns)
Rate single trigger	Synchronized on internal Timers or soft Command
Channel Output pulse T1 to T2 (and T3 to T8)	
Amplitude	1.5 V to 5 V in step of 1 mV into 50 Ω or 3.0 V to 10 V in step of 2 mV into high impedance (>1 kΩ)
Rise/Fall Time	1 ns / 1 ns into 50 Ω or 2 ns / 2 ns into high impedance @ full scale
Width	10 ns to 10 s in step of 5 ns
Pulse Polarity	Positive or Negative
Burst Mode	Burst count = 1 to 1 000 000 000, adjustable period in step of 5 ns
MUX Mode	Any channel may be ORed' to all outputs
External Clock reference	
Threshold	0 V, internal 50 Ω
Level / shape	Min -10 dBm, typical 6 dBm
Frequency	10 MHz to 240 MHz, user programmable in steps of 0.25 MHz up to 120 MHz, then user programmable in steps of 0.50 MHz
Clock output	
Level /shape	>500 mV p-p, into 50 Ω, AC coupling
Frequency	100 MHz if internal clocked or same as external clock if external clocked (100 MHz with option 3)
Gate or second trigger or daisy chaining	
Function	Gate or second External Trigger with adjustable threshold or daisy chaining to second GFT1804
Input	Active high or low in gate mode, positive/negative slope with rate <40 MHz in trigger mode
GPIO: Input or output lines	
4 x GPIO	Input or output, 0 or 3 V level, impedance > 20 kΩ input & 100 Ω output
General	
Interface Control	USB to UART, Ethernet 10/100 Mb/s, Bluetooth in option
User's sets	8 sets to save or recall eight specific configurations
Software tools	Free Drivers for Windows 10/11, Linux, USB application with GUI is furnished
Power Voltage	+5 Volts, 2.5 W to 15 W according to configuration
Power supply	USB or External AC (80 - 264 V/47-63 Hz) to DC (5 V / 4 A), adapter furnished
Size / Weight	150 x 120 x 20 mm / <1 kg
Options	
Option 1:	Extension to 4 channels
Option 2:	Extension to 8 channels (size = 150 x 120 x 40 mm)
Option 3:	1 ps delay resolution, only available with GFT1804-2C or 4C model, channel to channel jitter <10 ps (at short delay), min width of 50 ns <u>Narrow pulse mode:</u> it allows min width of 3 ns in step of 1 ps on 2 channels outputs
Option 4:	(Bank of 2 channels) 3 V to 10 V channel output, width= 10 ns to 10 ms, rise/fall time = 1/1 ns into 50 Ω
Option 5:	(Bank of 2 channels) 15 V to 50 V channel output, width = 50 ns to 5 μs, rise/fall time = 3/15 ns into 50 Ω
Option 6:	(Bank of 1 channel) with a max of 2 differential LVDS or HSTL outputs, 175 mV to 1200 mV, width = 10 ns to 10 s, rise/fall time = <0.5/0.5 ns into 100 Ω differential <u>Narrow pulse mode:</u> it allows min width of 1 ns in step of 100 ps, or 500 ps min width in step of 1 ps with option 3 (1 ps resolution)
Option 7:	(Bank of 1 channel) LVDS differential clock output programmable up to 1 GHz (available in Q1 2024)
Option 8:	Bluetooth
Option 9:	5" SMB to BNC cable

Ordering information

Model GFT1804-2C	2 channel mini pulse & delay generator (base version)
Model GFT1804-4C	4 channel mini pulse & delay generator (with option 1)
Model GFT1804-8C	8 channel mini pulse & delay generator (with option 2)

Operating Information

Block diagram of the generator

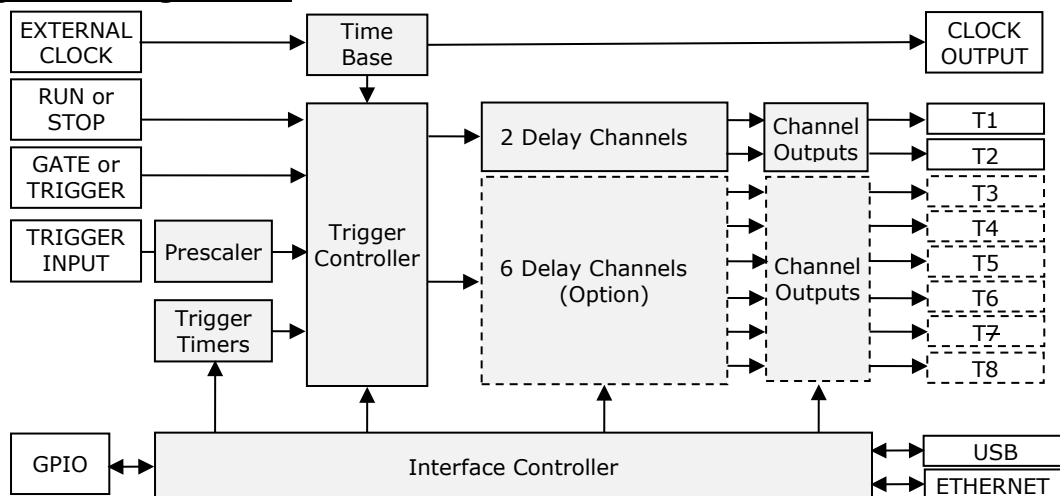

Time base: This function provides a 200 MHz time base from an internal reference or an external 10 MHz to 240 MHz reference. The internal time base is available (Clock out) on SMB connector.

Trigger controller: This function provides 2 Trigger Modes,

- **External Trigger Mode:** In this mode, a rising edge on "Trigger Input" triggers all selected delay channel. On every channel trigger rate can be single or repetitive or inhibited.

A Prescaler may be used to divide the Trigger Input frequency by integer value from 1 to 1 000 000 000

- **Internal Trigger Mode:** in this mode delay channels can be triggered from 3 frequency programmable Timers. On every channel trigger rate can be single synchronized on trigger sources (trigger input, Timers, Command) or repetitive or burst or inhibited.

The seven (7) Trigger sources that are possible for each channel are presented in a below chart.

	Trigger sources						
	Trigger input	Gate input	Timer N°1	Timer N°2	Timer N°3	Command	Inhibited
External mode	X	X					
Internal mode			X	X	X	X	X

Trigger sources

"Gate Input" allows to inhibit quickly all selected channel Outputs. This input function can be selected as a second External Trigger or an input/output for daisy chaining two GFT1804 generators.

Run or Stop button enables or disables the output for any channels.

Delay Channel: They are 2 independent delay channels (or 4 or 8 in option). The delay from selected trigger source is programmable up to 100 seconds in 100 ps increments (1 ps in option).

Channel Output

Each delayed output pulse (T1 to T2 or T3 to T8) can be independently adjustable in level (1.5 V to 5 V in 1 mV steps), width (10 ns to 10 s in 5 ns steps), and polarity, and may be ORed' to all other outputs. The outputs are designed to drive 50 Ω load. On "High impedance" load, output level will be twice.

In option every channel output level can be 3 V to 10 V or 15 V to 50 V or under LVDS or HSTL standard (ask to the factory for mixed channel output level configuration).

Burst mode: On each Channel Output, pulse number can be adjusted with Burst count and Burst period.

Narrow pulse mode (available with option 3 or with option 6): this mode uses two delay channels, one to start the output pulse, and the other one to stop the pulse. So, in this mode, the output pulse can be narrower and precisely adjusted in time.

Interface Controller: It manages internal functions and user interface. All the parameters can be remote controlled via USB to UART and Ethernet (10/100 Mb/s). A Bluetooth interface is available in option. All parameters values are automatically saved and can be stored in 8 different user sets.

"GPIO": Four lines, input or output, under software command allows to control other devices.

Power On: the GFT1804 is configured to start automatically when powered by the DC +5V power jack (the power On/Off switch on the front of the card is disabled).

Example of channel outputs mode

Mode repetitive and single

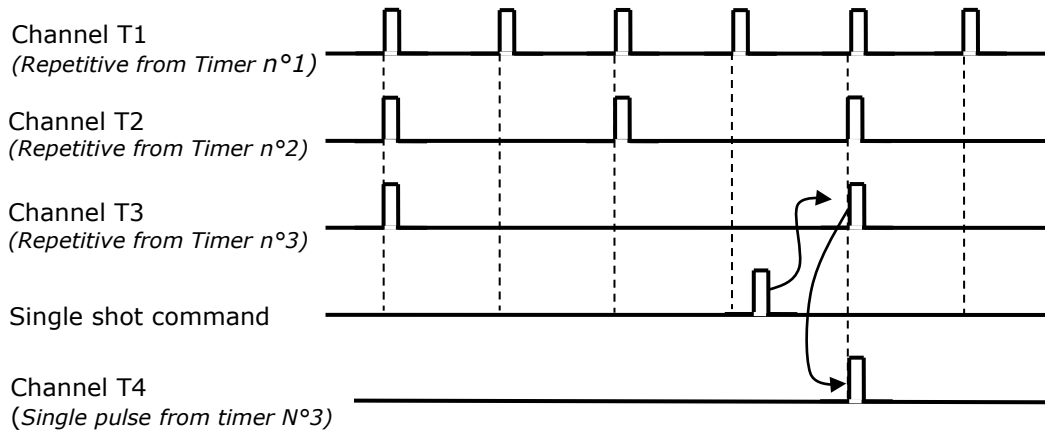

Mode burst and Mux

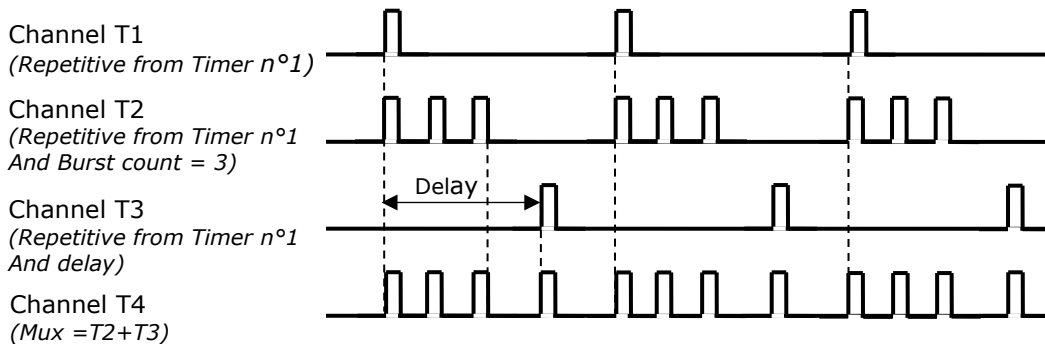

Pulse picking (Synchronized on Timer N°3)

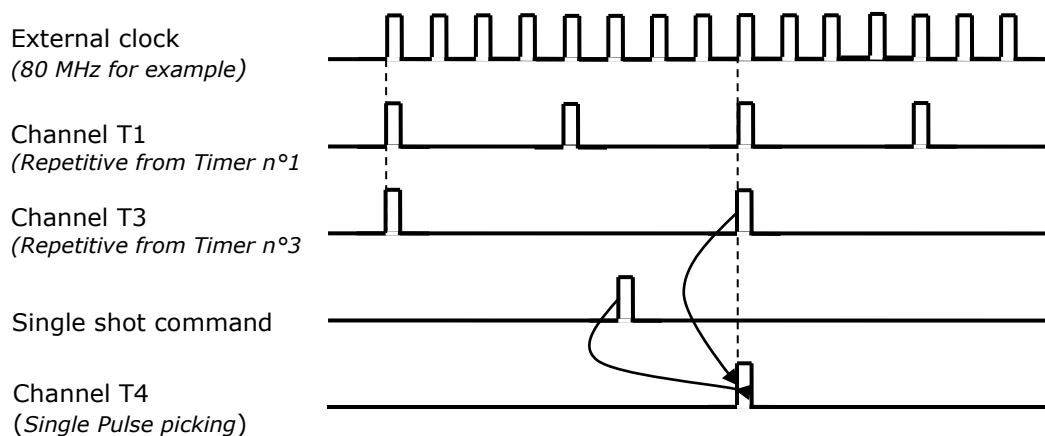

Example of output pulses

5 V into 50 Ω base version

Rt = 680 ps, Ft = 740 ps

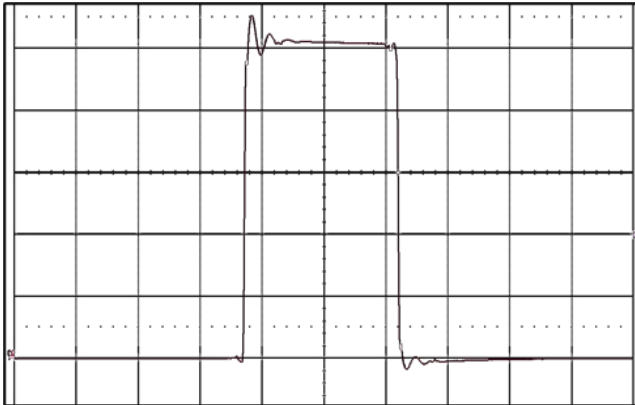

(20 ns/div, 1.0 V/div)

10 V, 10 ns with option 3

Rt = 790 ps, Ft = 770 ps

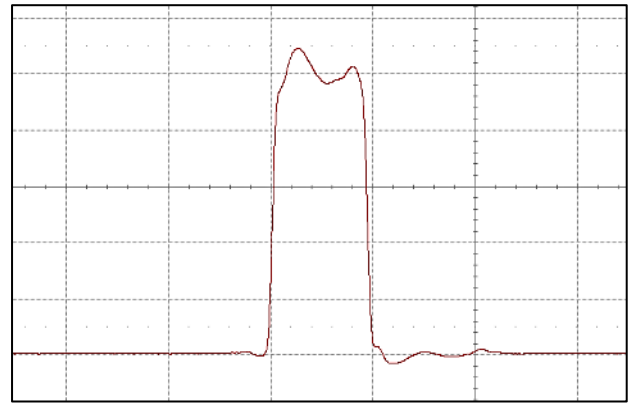

(10 ns/div, 2.0 V/div)

10 V, 10 ms width pulse with option 3

Rt = 800 ps, Ft = 800 ps

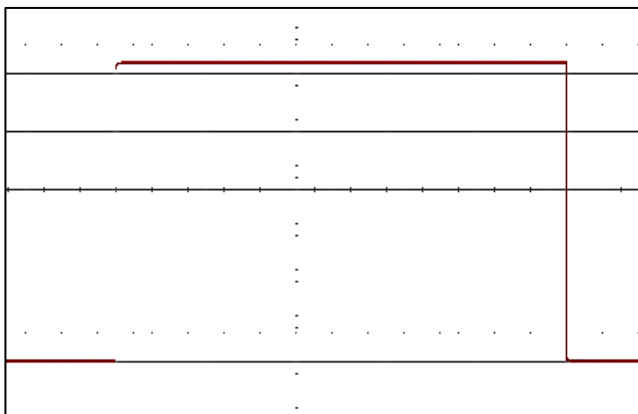

(2 ms/div, 2 V/div)

10 V, 10 ns width in burst mode with option 3

Into 50 Ω at 50 MHz rate

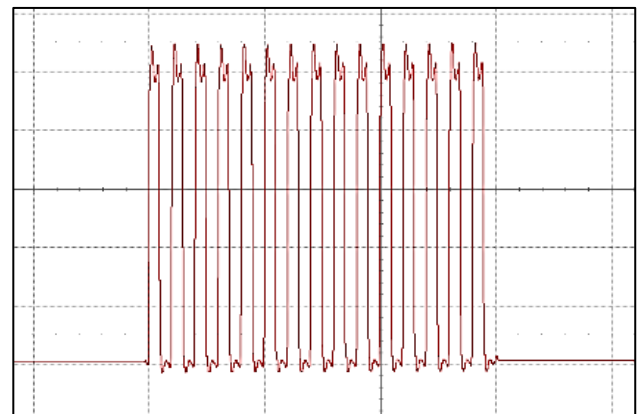

(100 ns/div, 2.0 V/div)

Narrow pulse mode with option 2

5 V and 3 to 4 ns multi-pulses widths

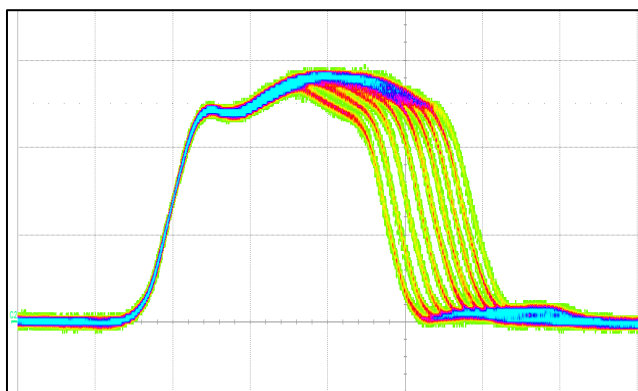

(1 ns/div, 2.0 V/div)

View from scope in infinite persistence

Narrow pulse mode with option 5 (LVDS)

1.1 V and 500 to 1500 ps multi-pulse widths

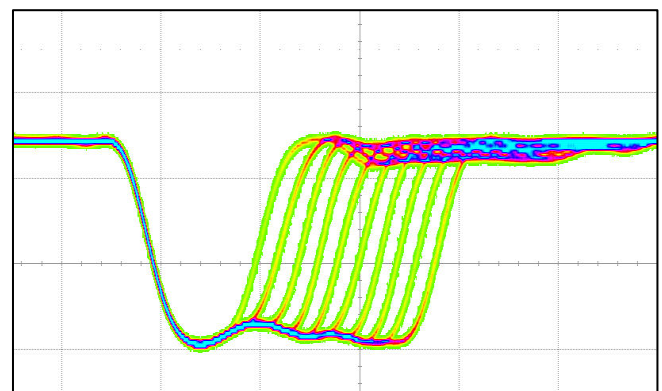

(500 ps/div, 0.5 V/div)

View from scope in infinite persistence

Control and software tools

There are two ways to control the generator:

Easy remote way via Ethernet and control panel web pages (without any specific software application). Web page, from embedded Web server, provides easy method to configure settings.

- A Main menu allows to display and control:
 - Trigger and clock system (trigger level, prescaler, clock input/output, trigger generators F1 or F2 or F3)
 - Delay channel (Trigger source, trigger rate, delay, amplitude / width / polarity of channel output pulse)
 - Extended delay channel settings (burst mode, gate and MUX mode)
 - "RUN" button enables the output for all delay channels.
 - "Trigger" button may be used to enable a "single trigger" synchronized with the selected trigger source
- A secondary menu selected with "parameter" button allows to change the IP address and configure specific parameters
- Another secondary menu selected with "GPIO" button allows to configure Input/output lines
- "Chart View" button opens a window to display in real time every channel output in a common time chart. Zoom & cursor functions make it possible to visualize and control time details (see example below)

The configuration information (all the settings) of the instrument is stored and saved in the GFT1804. The web page can be opened via standard browser like Edge, Mozilla Firefox or Chrome. After connecting a cable from the GFT1804 Ethernet port to your computer network, enter the GFT1804 IP address into your PC's browser (the default IP address can be identified in User's manual). The browser will automatically open the control panel web page on your PC.

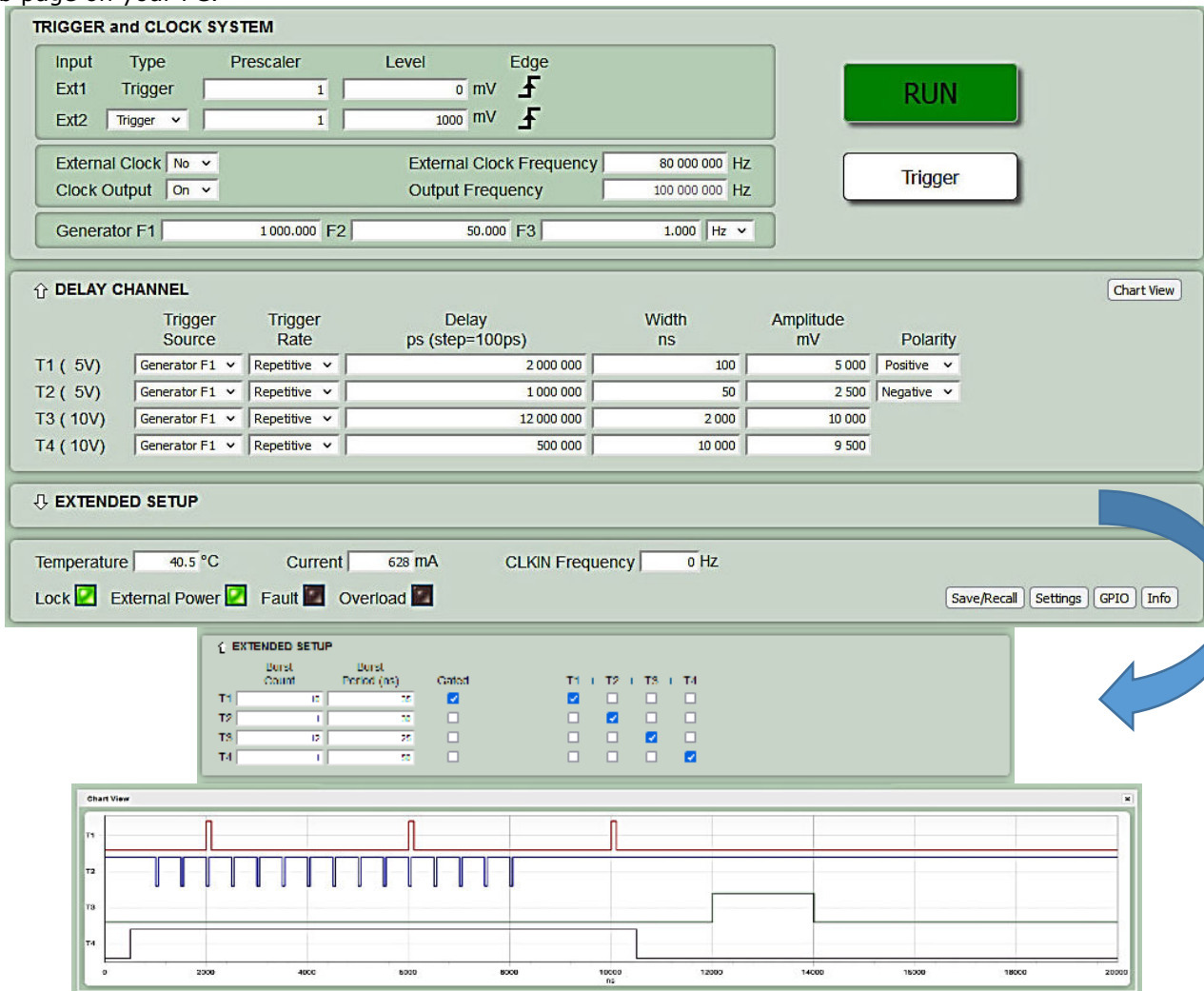

The screenshot displays the control panel web page for the GFT1804 Pulse & Delay Generator. It is divided into several sections:

- TRIGGER and CLOCK SYSTEM:** Contains input configuration for Ext1 and Ext2 (Type, Prescaler, Level, Edge), External Clock settings (No/On, Frequency), and Generator F1, F2, F3 frequency settings. Includes a large green "RUN" button and a "Trigger" button.
- DELAY CHANNEL:** A table with columns for Trigger Source, Trigger Rate, Delay (ps), Width (ns), Amplitude (mV), and Polarity. It lists four channels (T1-T4) with their respective settings.
- EXTENDED SETUP:** Shows Temperature (40.5 °C), Current (628 mA), and CLKIN Frequency (0 Hz). It includes status indicators for Lock, External Power, Fault, and Overload, along with "Save/Recall", "Settings", "GPIO", and "Info" buttons.
- EXTENDED SETUP (Detailed):** A sub-section for configuring Burst Count, Burst Period (ns), and Gate for each channel (T1-T4), with checkboxes for T1, T2, T3, and T4.
- Chart View:** A real-time waveform display showing the outputs of channels T1, T2, T3, and T4 over a time period from 0 to 20000 ns.

Control panel web page with Real Time Chart View under

General remote way via Ethernet or USB and software application (see examples in the User's manual). A USB application with GUI similar as web page control panel web page is furnished.

Input & Output

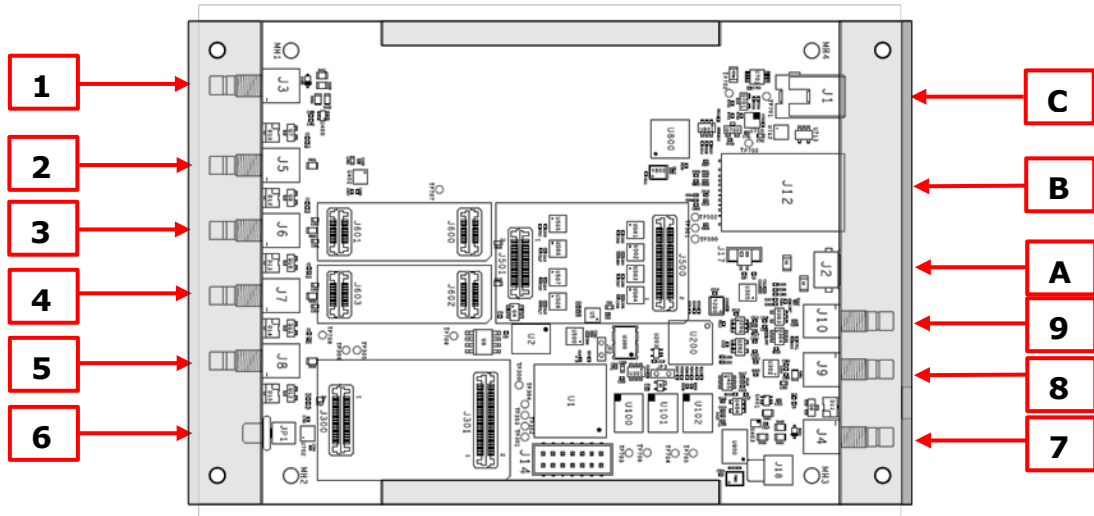

GFT1804 Top view

Connectors, switch

• Connector	
1	Trigger input: SMB connector
2	T1 channel output: SMB connector
3	T2 channel output: SMB connector
4	T3 channel output: SMB connector
5	T4 channel output: SMB connector
• Switch	
6	Power ON/OFF and RUN/STOP triggers (not active on GFT1804)

• Connector	
7	Gate input: SMB connector
8	External Clock: SMB connector
9	Clock output: SMB connector
A	USB connection: micro AB connector
B	LAN connection: RJ45 connector (B-Top) GPIO: SMH-103 Samtec (B- Bottom)
C	+5 V DC power: Jack 2.10 mm

Pulse shaping modules

Model	Description
GFT101	Electrical to optical Pulse Converter
GFT200	Optical to electrical converter: combined with GFT101 it allows to transmit fast pulse up to 1 Km
GFT300	Sub nanosecond Pulse Stretcher from pick up diode to provide GFT1804 clock reference
GFT614	1 to 4 line 50 Ω Driver, up to 150 MHz rate
GFT632	15 to 70 V amplitude, <2 ns rise time into 50 Ω, Pulse Generator
GFT644	4 channel, 50 Ω TTL line Driver, up to 150 MHz rate