

Features

- 4 independent delay channels
100 ps delay resolution
50 ps channel to channel RMS jitter
- Output pulse 1.5 to 5 V into 50 Ω, 1 ns rise time with independent control of width, polarity, amplitude, burst and MUX mode
- Up to 50 MHz trigger rate
- 7 triggers sources: Two External with pre-scaler or three internal or one command
- Gate (or second trigger) input
- External clocking up to 240 MHz
- Controlled via Ethernet (or USB in option)
- Output pulse options: 10 V or 50 V or LVDS level

Applications

- System Laser Timing Control
- ATE Application
- Laser Pulse Piking
- Precision Pulse Application
- Instrument Triggering
- Components Test equipment
- Embedded OEM application (in option)
- Multi-clock generation
- Serial data generation (adjustable in skew) with "burst" and "MUX" mode"



GFT1064 and Laptop with IHM to control settings

Description

The GFT1064 Mini Pulse & Delay Generator provides 4 independent delayed pulses. Delays up to 100 seconds can be programmed with 100 ps resolution and channel to channel jitter less than 50 ps RMS.

BNC outputs deliver 1.5 V to 5 V, 1 ns rise time pulses, into 50 Ω. Pulse amplitude, polarity, width and burst count are adjustable on each output channel. In option, pulse amplitude can be 3 V to 10 V or 15 V to 50 V into 50 Ω or LVDS level.

The model GFT1064 also offers two inputs or three internal synchronized Timers (adjustable from 0.01 Hz to 50 MHz) or software command for triggering all selected delay channel. Either trigger rate may be set as one-shot or repetitive. Gate Input allows to quickly inhibit all selected channel Outputs. This input function can be selected as a second External Trigger.

The generator uses an internal 100 MHz TCXO clock reference, or an external user programmable (from 10 MHz to 240 MHz) clock (sine or square).

On front panel two indicators are included to indicate when input or output are running, and the power is "ON".

GFT1064 parameters can be remote controlled via Ethernet or USB to UART in option.

Application example: The GFT1064 is well suited to synchronize all the devices of a Picosecond Laser System with only one compact unit and one GUI. In this application the "Clock reference input" of the delay generator receives a reference signal (80 MHz for example) from laser oscillator via an O/E (optical to electrical converter)

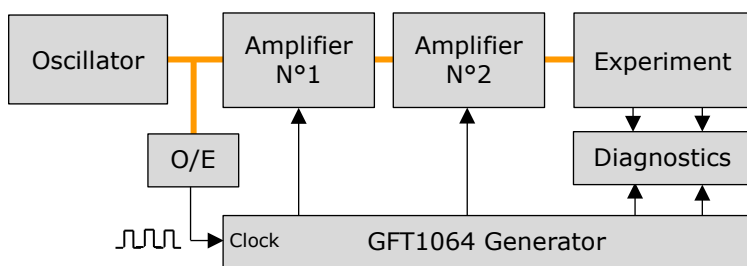

Picoseconde laser System

From the GFT1064 Generator each amplifier (Pump-laser, Q-switch, Pockel cell ...) or diagnostic instruments (Digitizer, Calorimeter, CCD camera ...) can receive repetitive or single pulses (adjusted in rate, delay, amplitude, polarity, and width) synchronized on "Clock reference input" with a very low jitter.

From generator 4 GPIO (input or output) under software control allow command for security or control to low frequency devices.



Specifications

Delay channels	
Number	4 independents
Range	100 seconds
Resolution	100 ps
RMS jitter	< 50 ps + delay x 10 ⁻⁷ , channel to channel < 1 ns, external trigger to any channel
Accuracy	< 250 ps + delay x 10 ⁻⁶
Time base	Internal 200 MHz, ±5 ppm stability
External Trigger Mode	
Input "TRIG"	Rate single or repetitive up to 40 MHz, with prescaler, adjustable threshold from +100 mV to +5 V (step 1 mV), adjustable positive or negative slope and 5 ns min pulse width
Trigger delay	< 85 ns (insertion delay)
Internal Trigger Mode	
Rate repetitive	From three Timers with frequency = 0.001 Hz to 50 MHz (in step of 5 ns)
Rate single trigger	Synchronized on internal Timers or soft command
Channel Output pulse T1 to T4	
Amplitude	1.5 V to 5 V in step of 1 mV into 50 Ω or 3.0 V to 10 V in step of 2 mV into high impedance (> 1 KΩ)
Rise/Fall Time	1/1 ns into 50 Ω or 2/2 ns into high impedance @ full scale
Width	10 ns to 10 s in step of 5 ns
Pulse Polarity	Positive or Negative
Burst Mode	Burst count = 1 to 1 000 000 000, adjustable period in step of 5 ns
MUX Mode	Any channel may be ORed' to all outputs
External Clock reference	
Threshold	0 V, internal 50 Ω
Level	Min -10 dBm, typical 6 dBm
Frequency	10 MHz to 240 MHz, user programmable in steps of 0.25 MHz up to 120 MHz then user programmable in steps of 0.50 MHz
Clock output	
Level	>500 mV p-p, into 50 Ω, AC coupling
Frequency	100 MHz if internal clocked or same as external clock if external clocked
Gate or second trigger	
Input	Gate or second External Trigger with adjustable threshold or daisy chaining to second GFT1064
Function	Active high or low in gate mode, positive/negative slope with rate <40 MHz in trigger mode
GPIO: Input or output lines	
4 x GPIO	Input or output, 0 or 3V level, impedance >20 kΩ input & 100 Ω output
General	
Interface Control	Ethernet 10/100Mb/s
Software tools	Free Drivers for Windows 10, Linux Embedded software running with standard browser (Edge, Firefox or Chrome) without specific application
Power consumption	15 W
Power supply	80 - 264 V/47-63 Hz
Weight	<5 kg
Size	19" x 1U x 33 mm
Options	
Option 1:	USB to UART interface control
Option 2:	OEM version (board level) with 2 or 4 channels (see model GFT1804)
Option 3:	(Bank of 2 channels) 3 V to 10V channel output, width = 10 ns to 10 ms, rise/fall time = 1/1 ns typ. into 50 Ω
Option 4:	(Bank of 2 channels) 15 V to 50 V channel output, width = 50 ns to 5 μs, rise/fall time = 3/15 ns into 50 Ω
Option 5:	(Bank of 1 channel) with a max of 2 differential LVDS or HSTL outputs, 175 mV to 1200 mV, adjustable width 10 ns to 1 s, rise/fall time = 0.5/0.5 ns into 100 Ω differential <u>Narrow pulse mode:</u> It allows min width of 500 ps in step of 100 ps

Operating Information

Block diagram of the generator

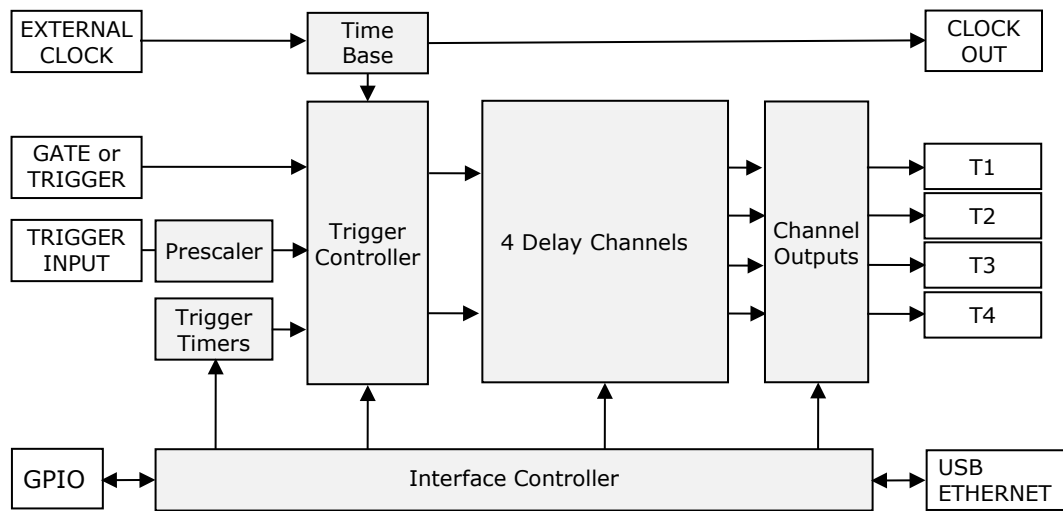

Block Diagram of the generator

Time base: This function provides a 200 MHz time base from an internal reference or an external 10 MHz to 240 MHz reference. The internal time base is available (Clock out) on the rear panel.

Trigger controller: This function provides 2 Trigger Modes.

-External Trigger Mode: In this mode, a rising (or falling) edge on input "Trigger input" triggers all delay channel. On every channel trigger rate can be single or repetitive or inhibited.

A Prescaler may be used to divide the Trigger Input frequency by integer value from 1 to 1 000 000 000

-Internal Trigger Mode: In this mode delay channels can be triggered from 3 frequency programmable Timers. On every channel trigger rate can be single or repetitive or burst or inhibited.

The seven (7) Trigger sources that are possible for each channel are presented in a below chart.

	Trigger sources						
	Trigger input	Gate input	Timer N°1	Timer N°2	Timer N°3	Command	Inhibited
External mode	X	X					
Internal mode			X	X	X	X	X

Trigger sources

"Gate Input" allows to inhibit quickly all selected channel Outputs. This input function can be selected as a second External Trigger

Delay Channel: They are 4 independent delay channels. The delay from selected trigger source is programmable up to 100 seconds in 100 ps increments.

Channel Output

Each delayed output pulse (T1 to T4) can be independently adjustable in level (1.5 V to 5 V in 1 mV steps), width (10 ns to 10 s in 5 ns steps), and polarity, and may be ORed' to all other outputs. The outputs are designed to drive 50 Ω load. On "High impedance" load, output level will be twice.

In option every channel output level can be 3 V to 10 V or 15 V to 50 V into 50 Ω or under LVDS standard (ask to the factory for mixed channel output level configuration).

Burst mode: On each Channel Output the number of pulses can be adjustable with Burst count and Burst period.

Narrow pulse mode: (available with option 5) This mode uses two delay channels, one to start the output pulse, and the other one to stop the pulse. So, in this mode, the output pulse can be narrower and precisely adjusted in time.

Interface Controller:

It manages internal functions and user interface. All the parameters can be remote controlled via USB to UART and Ethernet (10/100 Mb/s).

All parameters' values are automatically saved.

"GPIO": Four lines, input or output, under software command allow to control other devices.

Example of channel outputs mode

Mode repetitive and single

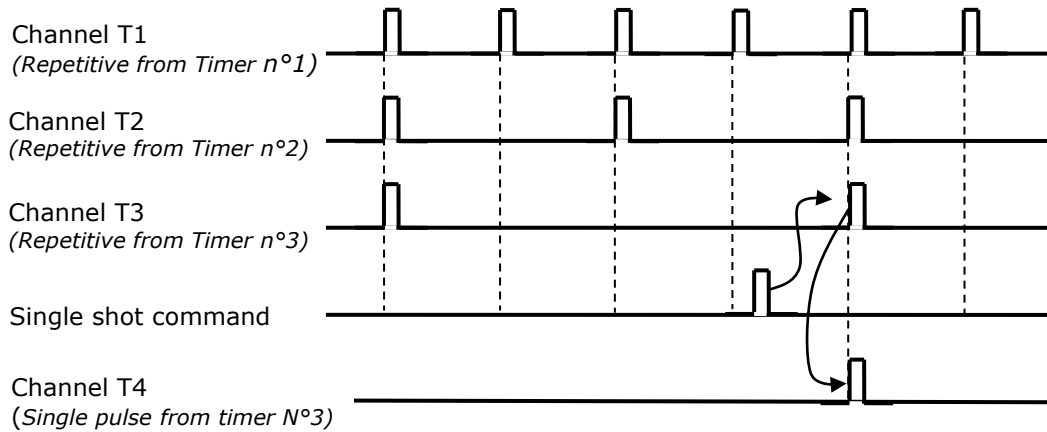

Mode burst and Mux

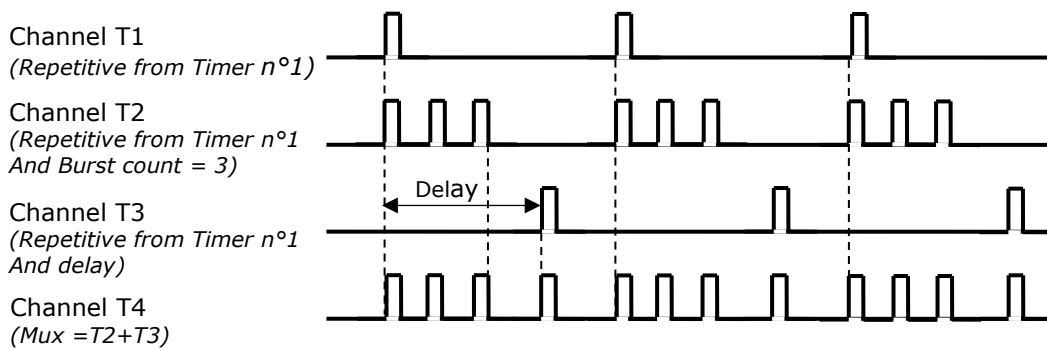

Pulse picking

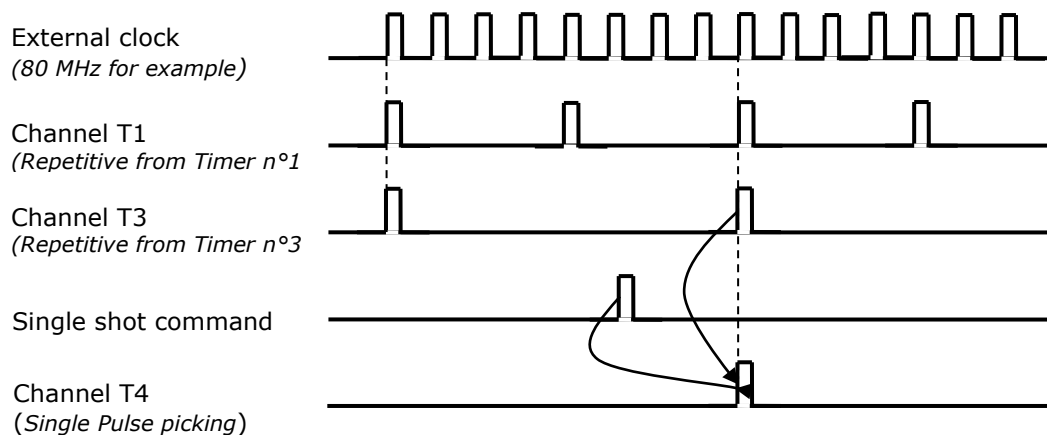

Example of typical output pulse

5 V output pulse into 50 Ω load
 $R_t = 677$ ps, $F_t = 739$ ps

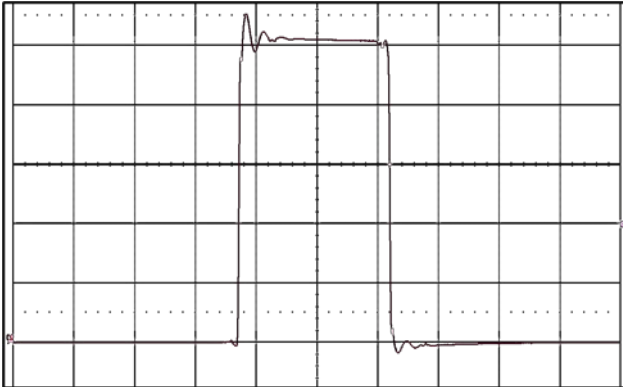

(20 ns/div, 1 V/div)

10 V output pulse into high impedance load
 $R_t = 1.73$ ns, $F_t = 1.91$ ns

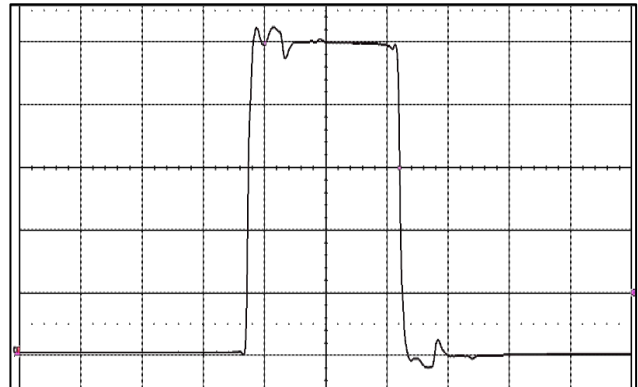

(20 ns/div, 2.0 V/div)

10 V, 10 ns width pulse with option 3
 $R_t = 788$ ps, $F_t = 766$ ps

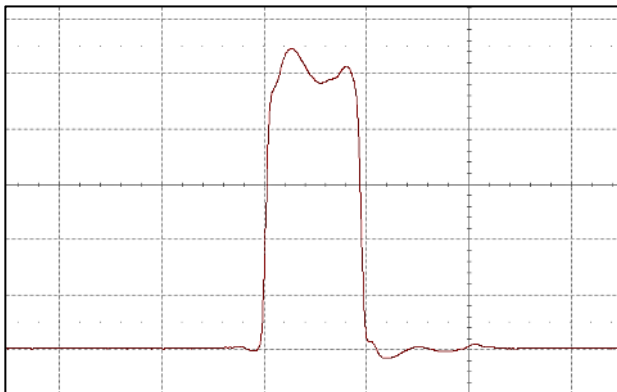

(10 ns/div, 2.0 V/div)

10 V, 10 ms width pulse with option 3
 $R_t = 800$ ps, $F_t = 800$ ps

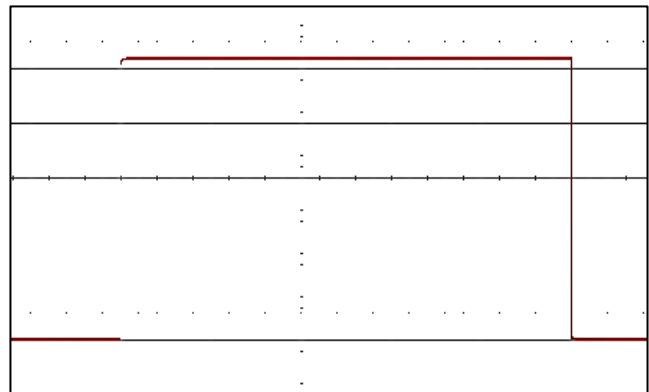

(2 ms/div, 2.0 V/div)

10 ns width in burst mode with option 3
 10 V into 50 Ω at 50 MHz rate

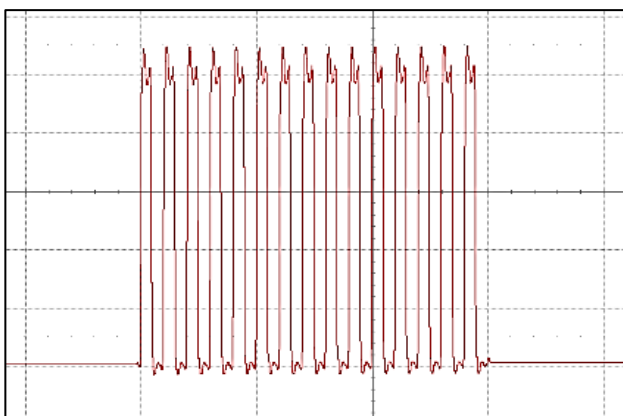

(100 ns/div, 2.0 V/div)

Narrow pulse mode with option 5 (LVDS)
 1.1 V and 500 to 1500 ps width multi-pulses

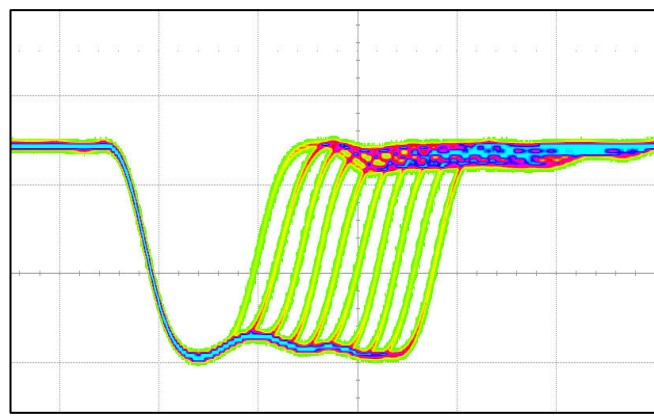

(500 ps/div, 0.5 V/div)

Control and software tools

There are two ways to control the generator

Easy remote way via Ethernet and control panel web pages.

Web page, from embedded Web server, provides easy method to configure settings.

- A Main menu allows to display and control
 - Trigger and clock system (trigger level, prescaler, clock input/output, trigger generators F1 or F2 or F3).
 - Delay channel (Trigger source, trigger rate, delay, amplitude / width/polarity of channel output pulse)
 - Extended delay channel settings (burst mode, gate, and MUX mode)
 - "RUN" button enables the output for all delay channels.
 - "Trigger" may be used to enable a "single trigger" synchronized with the selected trigger source
- A secondary menu selected with "parameter" button allows to change the IP address and configure specific parameters
- Another secondary menu selected with "GPIO" button allows to configure Input/output lines

The configuration information (all the settings) of the instrument is stored and saved in the GFT1064.

The web page can be opened via Edge, Mozilla Firefox or Chrome.

After connecting a cable from the GFT1064 Ethernet port to your computer network, enter the GFT1064 IP address into your PC's browser (the IP address can be identified in User's manual). The browser will automatically open the control panel web page on your PC.

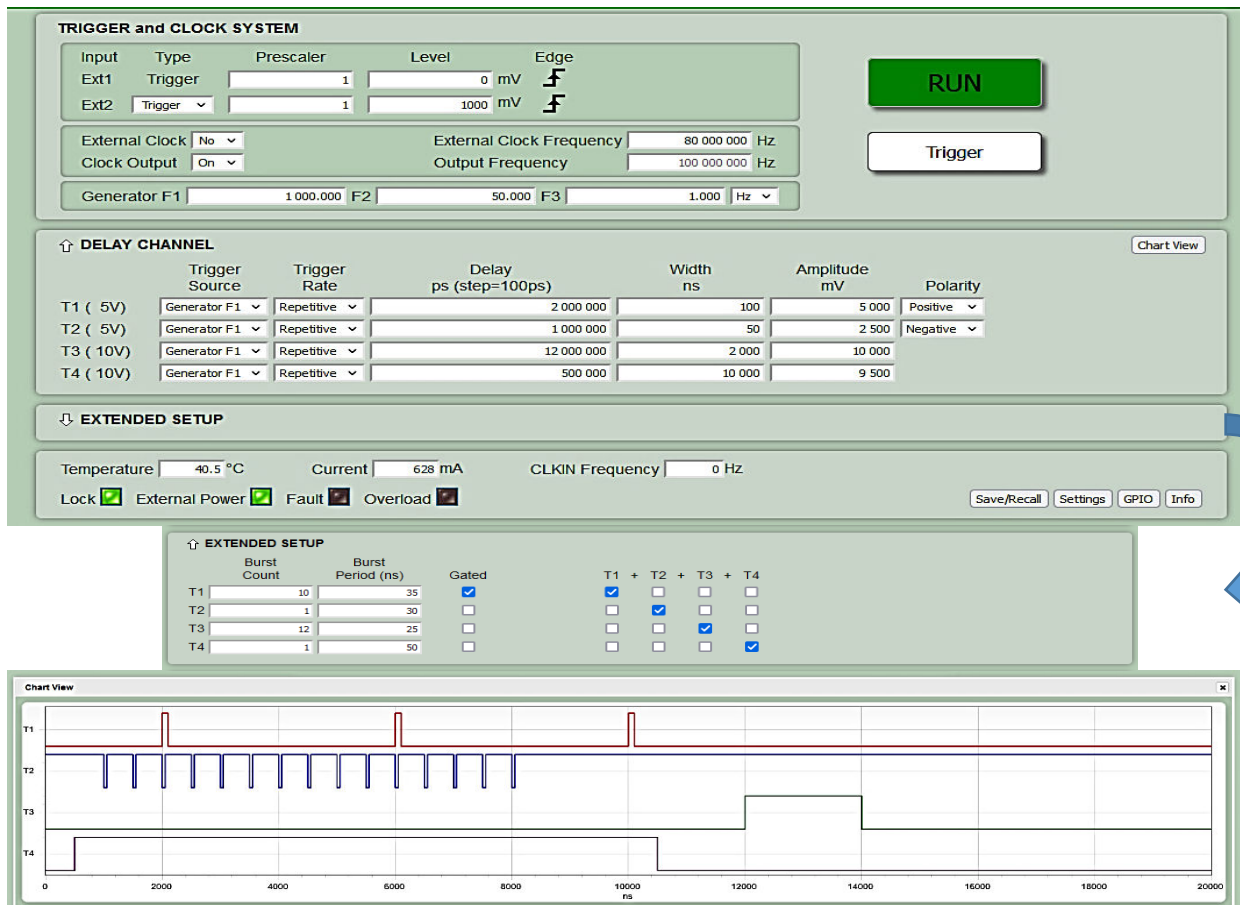

Control panel web page

General remote way via Ethernet or USB and software application (see examples in the User's manual)

Stand alone: The GFT1064 can be used without PC; PC is only needed to change the pulse characteristics. If this mode (auto POWER and auto RUN are ON) when the unit is powered up, it will start output pulses automatically.

Front and rear panel

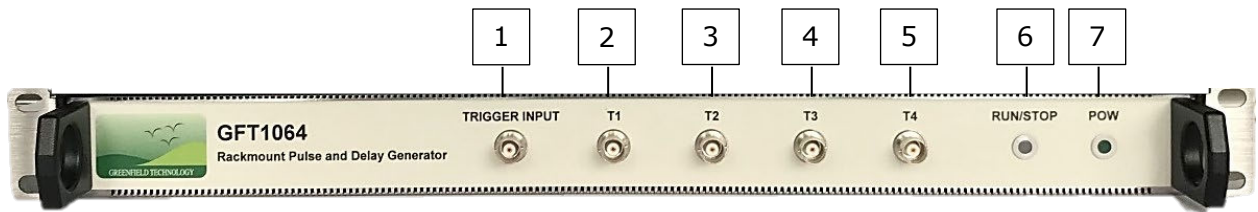

Front panel

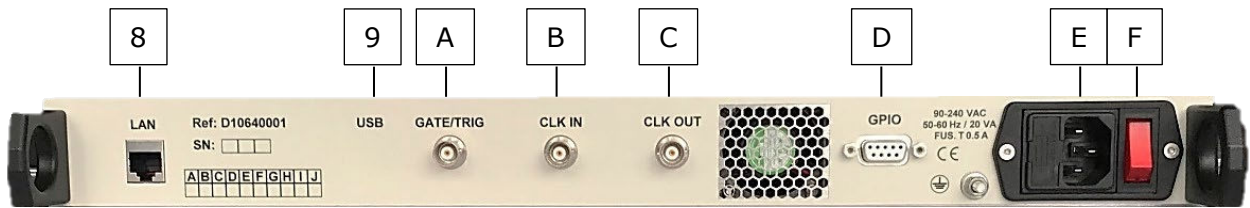

Rear panel

Connectors, switch

Front panel		Rear panel	
• Connector		• Connector	
1	Trigger input: BNC connector	8	LAN connection: RJ45 connector
2	T1 channel output: BNC connector	9	USB connection: USB 2.0 B connector
3	T2 channel output: BNC connector	A	Clock input: BNC connector
4	T3 channel output: BNC connector	B	Clock output: BNC connector
5	T4 channel output: BNC connector	C	Gate input: BNC connector
• Indicators		D	GPIO: SUB-D connector
6	RUN/STOP: Indicates the unit mode: Yellow when in STOP mode or Green when in RUN mode state	E	AC power plug (90 -240 VAC)
		• Switch	
7	POW: Indicates the unit is powered	F	Power On/off

Pulse shaping modules

Model	Description
GFT101	Electrical-to-optical Pulse Converter
GFT144	4 channel programmable delay module in 0.5 ps increments
GFT200	Optical to electrical pulse converter provide 10 V under 50 Ω
GFT300	Sub nanosecond Pulse Stretcher from pick up diode to provide GFT1064 clock reference
GFT614	1 to 4 lines, 150 MHz 50 Ω line Driver Module
GFT632	32 - 70 V, <2 ns rise time under into 50 Ω, Pulse Generator
GFT644	4 channel, 150 MHz, 50 Ω line Driver Module